

液晶屏37P接口电路

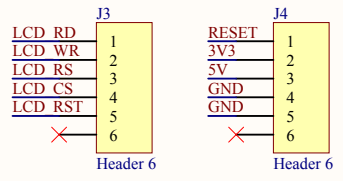

Arduino排针接口电路

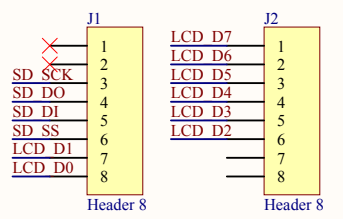

扩展接口

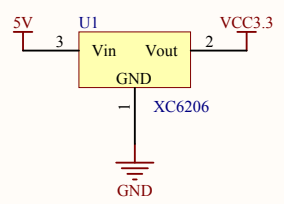

5V转3.3V电路

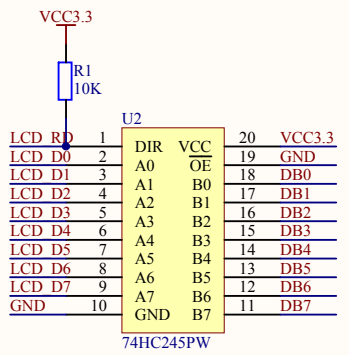

电平转换电路

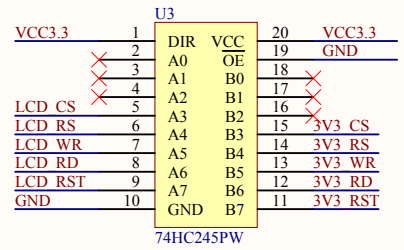

电平转换电路

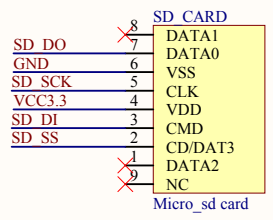

SD卡扩展接口电路

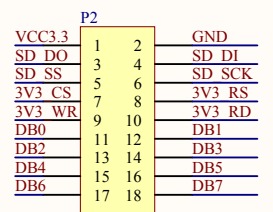

扩展接口

Title			
Size	Number	Revision	
A4			
Date:	2018-06-28	Sheet of	
File:	E:\project\2.8inch\Main.SchDoc	Drawn By:	