

液晶屏37P接口电路

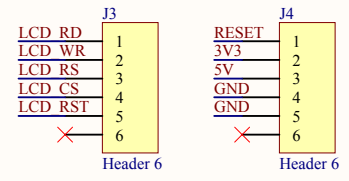

Arduino排针接口电路

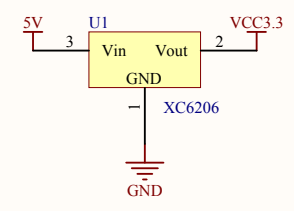

5V转3.3V电路

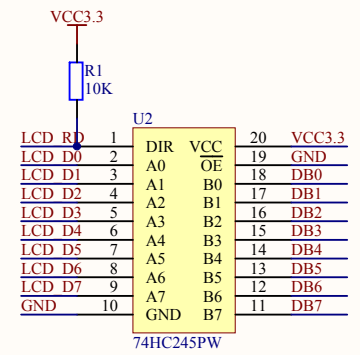
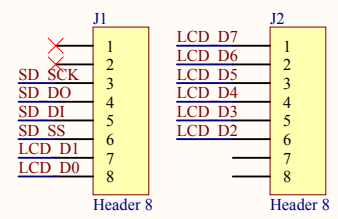

电平转换电路

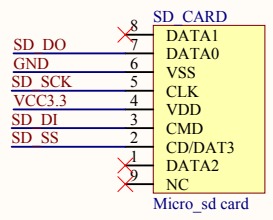

SD卡扩展接口电路

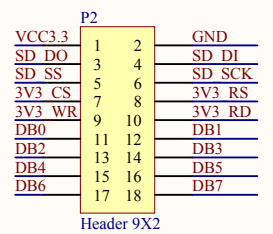

扩展接口

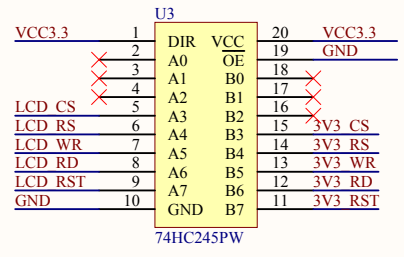

电平转换电路

Title		
Size	Number	Revision
A4		
Date:	2018-06-28	Sheet of
File:	E:\project\2.6inch\Main.SchDoc	Drawn By: