

PRODUCT : LCD MODULE
MODEL NO. : QDTFT1801
SUPPLIER : QDtech
DATE : March28,2018

SPECIFICATION

Revision:1.1

QDTFT1801

For Customer's Acceptance	
Approved by	Comment

	Signature	Date
Prepared by		
Checked by		
Approved by		

Contents

1	General Description	3
1.1	Features	3
1.2	Application	3
2	Outline Dimension	3
3	Electrical Characteristics	5
3.1	TFT-LCD Module	5
3.2	Back-Light Unit.....	5
4	TFT-LCM Interface Specification	6
5	Optical Specification.....	7
6	Environment Absolute Maximum Ratings	8
7	Reliability Test Items	19
8	Inspection Standard.....	10
9	Package	11
10	Precautions	12
10.1	Handling	12
10.2	Storage	12
10.3	Operation	13
10.4	Touch Panel Mounting Notes	13
10.5	Others	14
11	Records of Version	14

1 General Description

QDTFT1801 is a transmissive type a-Si TFT-LCD (amorphous silicon thin film transistor liquid crystal display) module, which is composed of a TFT-LCD panel, a driver circuit a backlight unit, The panel size is 1.77inch and thresolution is 128x160. High image quality a-Si TFT LCD module. Partial-screen display function is available. Sleep and Stand-by modes are available for power saving.

1.1 Features

No	Item	Specification	Remark
1	Display Mode	High Resolution & Wide View	
2	Screen Size	1.77inch (diagonal)	
3	Resolution	128XRGBX160	
4	Color Number	262K TFT	
5	Color Arrangement	RGB-stripe	
6	Driver IC	ST7735S	
7	Back Light	White LED*2	
8	Viewing Direction	12 O'clock	
9	Interface	SPI4W 1DATA	
10	Surface Treatment	UV Cut	
11	touch panel		

1.2 Application

- ◆ Mobile phone.
- ◆ Portable multimedia device.

2 Outline Dimension

The mechanical detail is shown in Fig. 1 and summarized in Table 1 below.

Parameter	Specifications	Unit
Outline dimensions	34.70(W) x46.7(H) x 2.4+/-0.1(D) (LCM,no include FPC)	mm
Active area	28.03(W) x35.04(H)	mm
Resolution	128(H)RGBx160(V) dots	-
Dot size	0.219x0.219	mm
Luminance value	220	cd/m ²

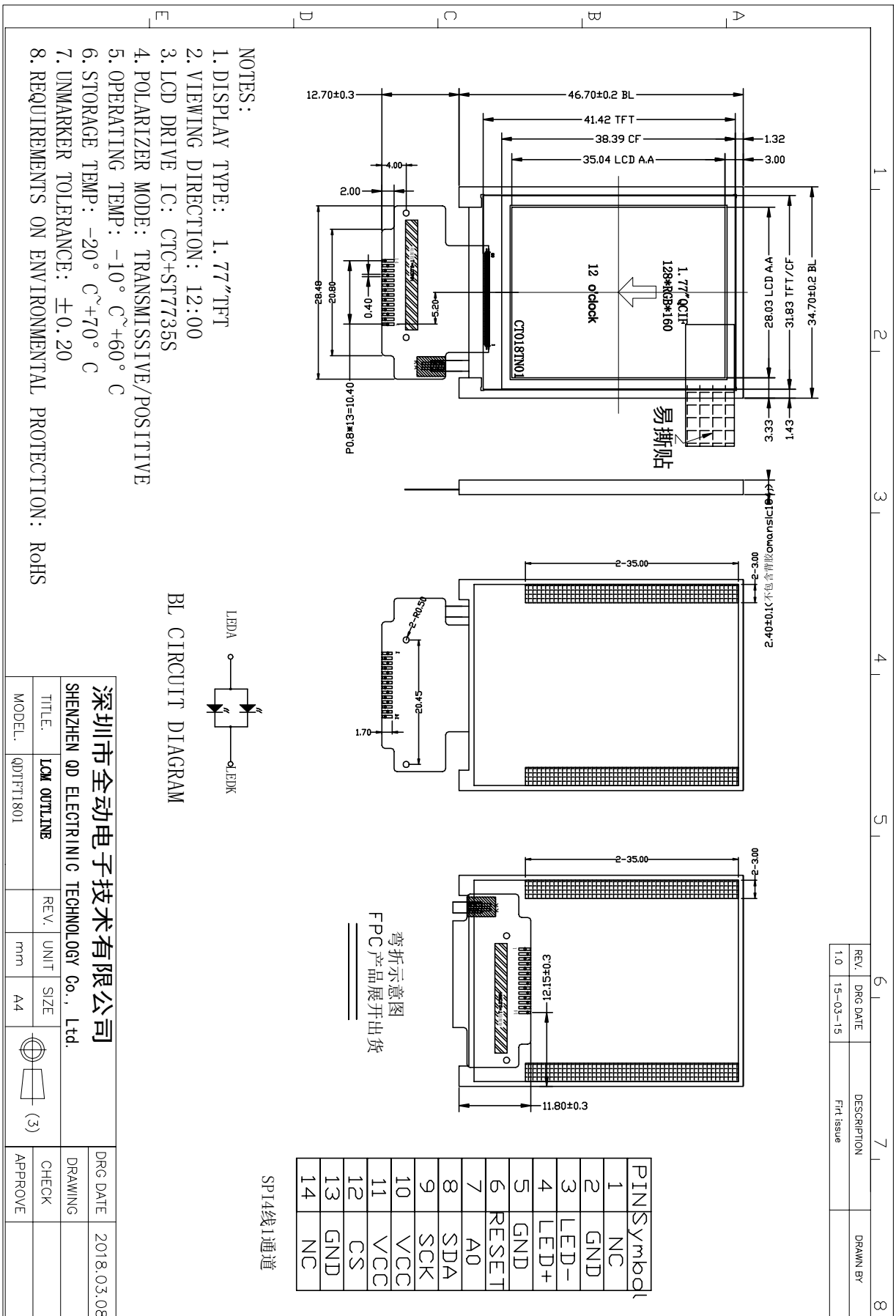

Figure 1: Module specification of the module

3 Electrical Characteristics

3.1 TFT-LCD Module

Item	Symbol	Unit	Condition	Min.	Typ.	Max.	Note
Power and Operation Voltage							
Analog Operating Voltage	VCI	V	Operating voltage	2.5	2.8	3.3	Note2
Logic Operating Voltage	VDDI	V	I/O supply voltage	1.65	2.8	3.3	Note2
Digital Operating voltage	VCORE	V	Digital supply voltage	-	1.5	-	Note2
Gate Driver High Voltage	VGH	V	-	12.0	-	21.0	Note3
Gate Driver Low Voltage	VGL	V	-	-12.5	-	-7.0	Note3
Driver Supply Voltage	-	V	[VGH-VGL]	-	-	32	Note3
Input and Output							
Logic High Level Input Voltage	VIH	V	-	0.7*VDDI	-	VDDI	Note1,2,3
Logic Low Level Input Voltage	VIL	V	-	VSS	-	0.3*VDDI	Note1,2,3
Logic High Level Output Voltage	VOH	V	IOL=-1.0mA	0.8*VDDI	-	VDDI	Note1,2,3
Logic Low Level Output Voltage	VOL	V	IOL=1.0mA	VSS	-	0.2*VDDI	Note1,2,3
Logic High Level Input Current	IIH	uA	-	-	-	1	Note1,2,3
Logic Low Level input Current	IIL	uA	-	-1	-	-	Note1,2,3
Logic Input Leakage Current	ILEA	uA	VIN=VDDI or VSS	-0.1	-	+0.1	Note1,2,3

Note 1: VDDI=1.65 to 3.3V, VCI=2.5 to 3.3V, AGND=VSS=0V, Ta=-30 to 70 (to +85 no damage) □.

Note2: Please supply digital VDDI voltage equal or less than analog VCI voltage.

3.2 Back-Light Unit

Item	Symbol	Min.	Typ.	Max.	Unit	Remark
Current	IF	60	70	80	mA	IF=80mA IF=3.2V
Forward voltage	VF	2.9	3.2	3.5	V	
Chroma	X	0.250		0.30		
	Y	0.250		0.30		
Brightness	L	4000			Cd/m2	
Uniformity	UBL	80			%	

- 2 LEDs multiple circuit
- The luminous intensity of LED is strongly dependent on the driving current.
- It is recommended the input of backlight to be constant current rather than constant voltage.

4 TFT-LCM Interface Specification

Pin No	Symbol	Description	Note
1	NC	NC	
2	GND	Ground	
3	LED-K	Cathode pin OF backlight	
4	LED-A	Anode pin of backlight	
5	GND	Ground	
6	RESET	Reset signal input Pin	
7	D/C	This pin is used to be serial interface clock.	
8	SDA	The data is latched on the rising edge of the SCL signal.	
9	SCL	Second Data lane in 2 data lane serial interface.	
10,11	VCC	Power supply input for LCM:2.8-3.3V	
12	CS	Chip select input pin.	
13	GND	Ground	
14	NC	NC	

5. Optical Specification

Note 1: The brightness test equipment setup

$I_B=60\text{mA}$, Field= 2° (As measuring "black" image, field= 2° is the best testing condition.)

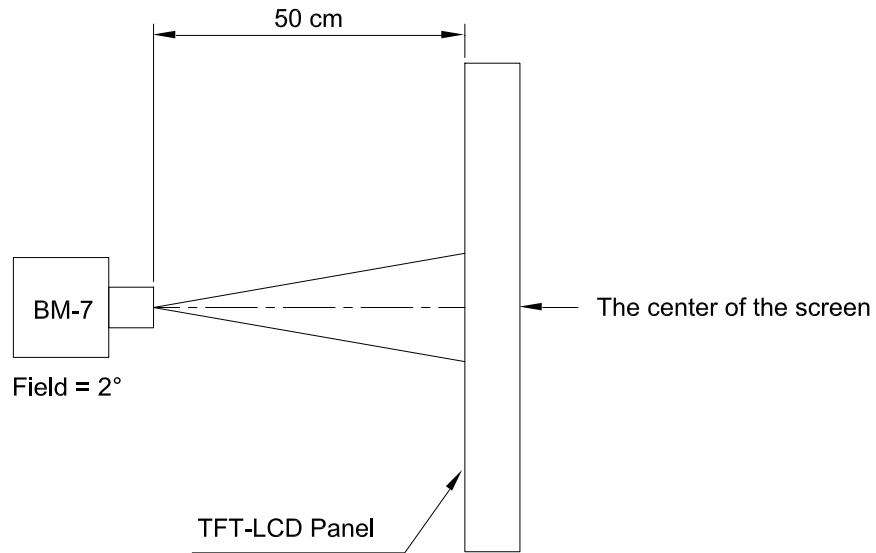

Note 2: Definition of contrast ratio (C.R)

$$\text{C.R} = \frac{\text{Brightness When LCD is at "White" State}}{\text{Brightness When LCD is at "Black" State}}$$

Note 3: Definition of response

time

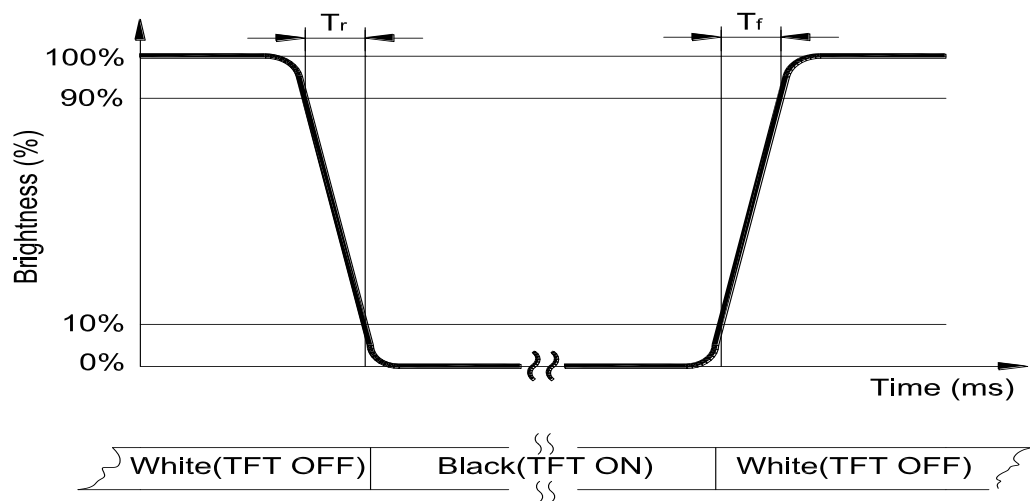

Note 4: Definition of viewing angle

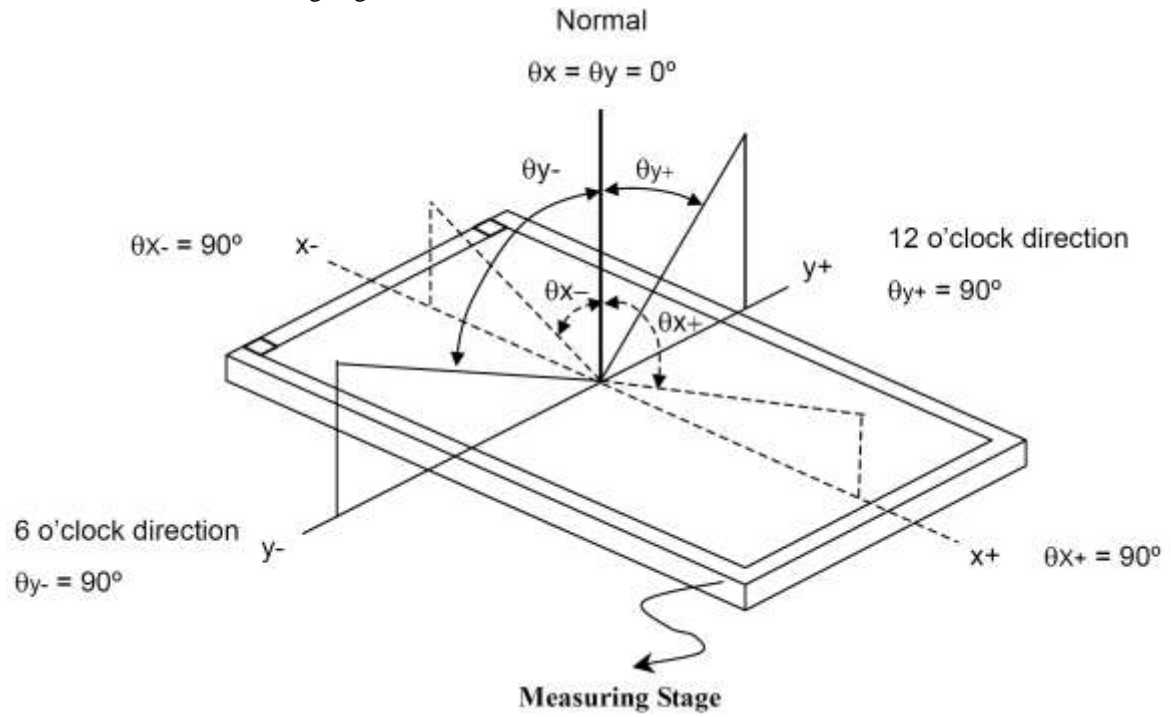

Note 5: Definition of uniformity (U_n)

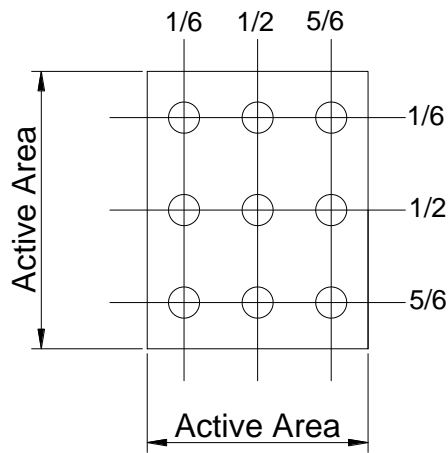

$$U_n = \frac{B_{\min}}{B_{\max}} \times 100\%$$

6 Environment Absolute Maximum Ratings

Item	Symbol	Min	Max	Unit	Remark
Operation temperature range	Top	-10	60	°C	Ambient
Storage temperature range	Tst	-20	70	°C	Ambient

- Corrosive gas environment is not acceptable.
- TFT-LCD color will change slightly depending on environment temperature. This phenomenon is reversible. Current reduction rate of LED backlight is according to the graph indicated below:

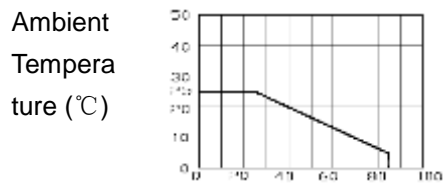

Allowable Forward Current (mA)

7 Reliability Test Items

Item	Test Condition		Criterion
High Temperature Storage	70 °C, 240 hrs		There should be no change which might affect the practical display function when the display quality test is conducted under normal operating condition.
Low Temperature Storage	-20 °C, 240 hrs		
High Temp. & High Humidity Storage	60 °C, 85% RH, 240 hrs		
Vibration Test (Non-operating)	Freq.:10~55~10 Hz, Amp.:1.5mm 1 hr for each direction of X, Y, Z		
Electrostatic Discharge Test (Non-operating)	Terminals	150 pF, 0 Ω, ±300 V, Contact	
	Panel	150 pF, 330 Ω, ±8 KV, Air	
Thermal Shock (Static)	-30°C, 30 min /80°C, 30 min, 20 cycles		
High Temperature Operation	60 °C, 240 hrs		
Low temperature Operation	-10 °C, 240 hrs		
High Temperature & High Humidity (Operating)	50 °C, 90% RH, 240 hrs		
FPC Peeling Strength Test	Pull speed: 50 mm/min, +90 °		> 400gf/cm

8 Inspection Standard

This standard apply to TFT module specification.

1. Inspection condition:
 Under daylight lamp 20~40W, product distance inspector'eye 30cm.incline degree 30° .

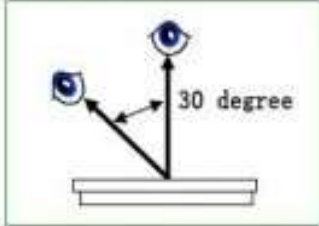

2. Inspection standard

NO.	Item	Inspection standard	Rate															
2.1	Dot	Case of Dot defect is below ① Bright Dot (whit spot) : "0" ② Dark Dot (black spot) : "0" (In case of Dark Dot on Main TFT LCD) - NG if there's full Dot defect. - Damaged less than the size of sub-pixel is not counted as defect - Dots darker than the size of sub-pixel are not defined as bright dot defect	minor															
		<table border="1"> <thead> <tr> <th>area size (mm)</th> <th>Acceptable number</th> </tr> </thead> <tbody> <tr> <td>$\Phi \leq 0.10$</td> <td>ignore</td> </tr> <tr> <td>$0.10 < \Phi \leq 0.15$</td> <td>3</td> </tr> <tr> <td>$0.15 < \Phi \leq 0.20$</td> <td>2</td> </tr> <tr> <td>$0.25 < \Phi \leq 0.25$</td> <td>1</td> </tr> <tr> <td>$0.25 < \Phi$</td> <td>0</td> </tr> </tbody> </table>		area size (mm)	Acceptable number	$\Phi \leq 0.10$	ignore	$0.10 < \Phi \leq 0.15$	3	$0.15 < \Phi \leq 0.20$	2	$0.25 < \Phi \leq 0.25$	1	$0.25 < \Phi$	0			
area size (mm)	Acceptable number																	
$\Phi \leq 0.10$	ignore																	
$0.10 < \Phi \leq 0.15$	3																	
$0.15 < \Phi \leq 0.20$	2																	
$0.25 < \Phi \leq 0.25$	1																	
$0.25 < \Phi$	0																	
2.2	line	<table border="1"> <thead> <tr> <th colspan="2">Size (mm)</th> <th>Acceptable number</th> </tr> </thead> <tbody> <tr> <td>ignore</td> <td>$W \leq 0.03$</td> <td>ignore</td> </tr> <tr> <td>$L \leq 4.0$</td> <td>$0.03 < W \leq 0.04$</td> <td>2</td> </tr> <tr> <td>$L \leq 4.0$</td> <td>$0.04 < W \leq 0.05$</td> <td>1</td> </tr> <tr> <td></td> <td>$0.05 < W$</td> <td>Treat with dot non-conformance</td> </tr> </tbody> </table>	Size (mm)		Acceptable number	ignore	$W \leq 0.03$	ignore	$L \leq 4.0$	$0.03 < W \leq 0.04$	2	$L \leq 4.0$	$0.04 < W \leq 0.05$	1		$0.05 < W$	Treat with dot non-conformance	
Size (mm)		Acceptable number																
ignore	$W \leq 0.03$	ignore																
$L \leq 4.0$	$0.03 < W \leq 0.04$	2																
$L \leq 4.0$	$0.04 < W \leq 0.05$	1																
	$0.05 < W$	Treat with dot non-conformance																

9 Package

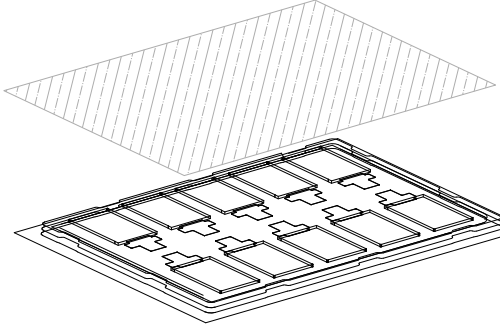
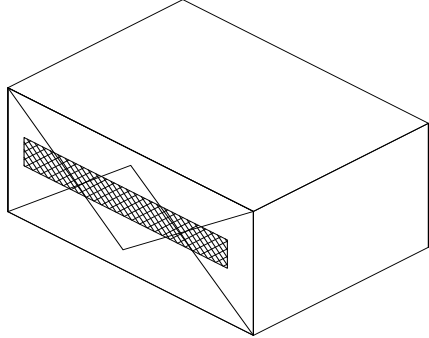
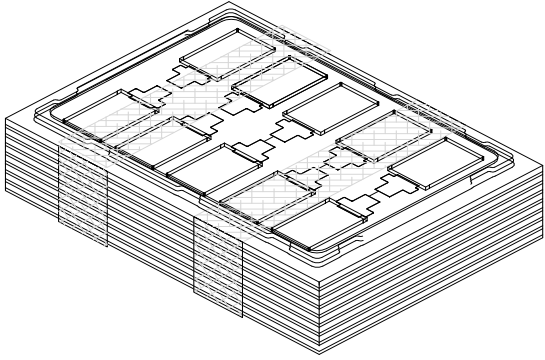
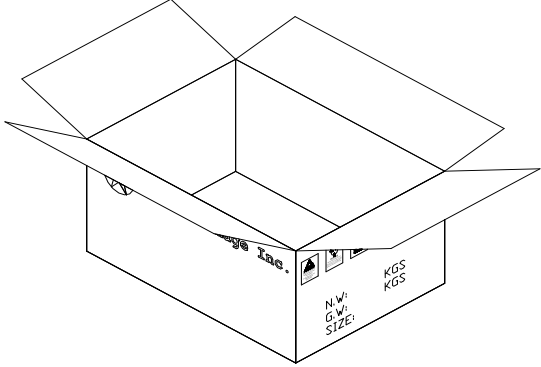
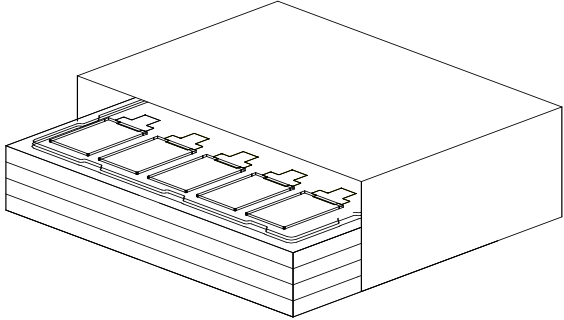
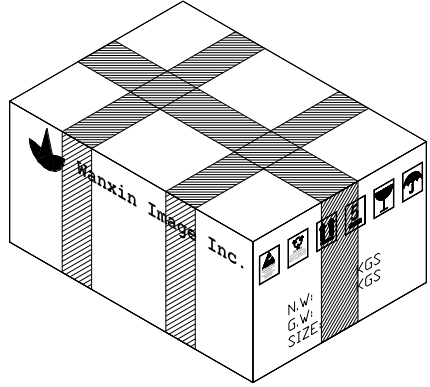
<p>1</p> 	<p>4</p> 
<p>10 pcs per tray + 1 cover (EPE)</p>	<p>Packing bag</p>
<p>2</p> 	<p>5</p> 
<p>15 trays + 1 dummy tray = 150 ps</p>	<p>Putting bag into carton Protected by 2 pieces of cushion EPE sheet</p>
<p>3</p> 	<p>6</p> 
<p>Putting trays into anti-electrostatic bag</p>	<p>Packing carton with sealing tape Carton outline size: 400×295×145 (mm)</p>

10 Precautions

Please pay attentions to the followings as using the LCD module.

10.1 Handling

- (a) Do not apply strong mechanical stress like drop, shock or any force to LCD module. It may cause improper operation, even damage.
- (b) Because the polarizer is very fragile and easy to be damaged, do not hit, press or rub the display surface with hard materials.
- (c) Do not put heavy or hard material on the display surface, and do not stack LCD modules.
- (d) If the display surface is dirty, please wipe the surface softly with cotton swab or clean cloth.
- (e) Avoid using Ketone type materials (e.g. Acetone), Toluene, Ethyl acid or Methyl chloride to clean the display surface. It might damage the touch panel surface permanently. The recommended solvents are water and Isopropyl alcohol.
- (f) Wipe off water droplets or oil immediately.
- (g) Protect the LCD module from ESD. It will damage the LSI and the electronic circuit.
- (h) Do not touch the output pins directly with bare hands.
- (i) Do not disassemble the LCD module.
- (j) Do not lift the FPC of Touch Panel.

10.2 Storage

- (a) Do not leave the LCD modules in high temperature, especially in high humidity for a long time.
- (b) Do not expose the LCD modules to sunlight directly.
- (c) The liquid crystal is deteriorated by ultraviolet. Do not leave it in strong ultraviolet ray for a long time.
- (d) Avoid condensation of water. It may cause improper operation.
- (e) Please stack only up to the number stated on carton box for storage and transportation. Excessive weight will cause deformation and damage of carton box.

10.3 Operation

- (a) When mounting or dismounting the LCD modules, turn the power off.
- (b) Protect the LCD modules from electric shock.
- (c) The Driver IC control algorithms stated above should always obeyed to avoid damaging the LSI and electronic circuit.
- (d) Be careful to avoid mixing up the polarity of power supply for backlight.
- (e) Absolute maximum rating specified above has to be always kept in any case. Exceeding it may cause non-recoverable damage of electronic components or, nevertheless, burning.
- (f) When a static image is displayed for a long time, remnant image is likely to occur.
- (g) Be sure to avoid bending the FPC to an acute shape, it might break FPC.
- (h) Most of the touch screens have air vent to equalize the inside air pressure to the outside one. The air vent must be open and liquid contact must be avoided as the liquid may be absorbed if the liquid is accumulated near the air vent.
- (i) For the fragility of ITO film, it should avoid to use too tapering pen as the input material.

10.4 Touch Panel Mounting Notes

- (a) If a cushion is used between bezel/housing and film must be choose as free as enough to absorb the expansion and contraction to avoid the distortion of film.
- (b) The cushion must be placed out of the Viewing Area.
- (c) Bezel/Housing edge must be posited between Key Area and Viewing Area. The edge enters the Key Area may cause unexpected input if the gap is too narrow or foreign particles like dusts exist between Bezel/Housing and ITO film.
- (d) Mounting example:

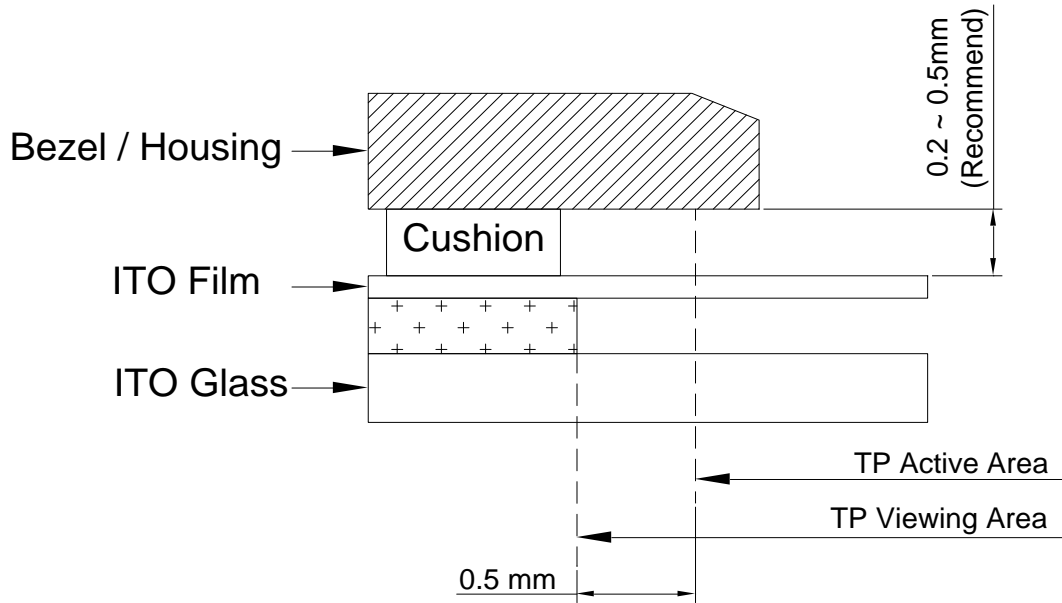

The corner part has conductivity. Do not touch any metal part after mounting.

10.5 Others

- a) If the liquid crystal leaks from the panel, it should be kept away from the eyes or mouth.
- b) For the fragility of polarizer, it is recommended to attach a transparent protective plate over the display surface.
- c) It is recommended to peel off the protection film on the polarizer slowly so that the electrostatic charge can be minimized.

11 Records of Version

Version	Revise Date	Page	Content
A	2017-11-21	All	New released